



PINKWOOD Ltd.
5929 6th St. NE
Calgary, Alberta T2K 5R5
(403) 279-3700
www.pinkwood.ca

PINKWOOD I-JOISTS

CSI Sections:

06 17 33 Wood I-Joists

1.0 RECOGNITION

Pinkwood Ltd. manufactures pre-fabricated wood I-joists for use as floor joists and rafters.

Pinkwood I-Joists were evaluated for use in lieu of sawn lumber joists in combustible construction. Pinkwood I-Joists may be used in lieu of sawn lumber in diaphragms to resist lateral loads when installed as required by the manufacturer's published instructions.

The structural and fire resistance properties of the I-joists comply with the intent of the provisions of the following codes:

- 2018, 2015 and 2012 International Building Code® (IBC)
- 2018, 2015 and 2012 International Residential Code® (IRC)

2.0 LIMITATIONS

Use of Pinkwood I-Joists recognized in this report is subject to the following limitations:

2.1 Cuts and notches in the flanges of the I-joists are not permitted. Where such alterations occur, the cuts and notches shall be reviewed by a registered design professional and repair action may be required.

2.2 The I-joists shall be properly braced in accordance with the Pinkwood installation instructions and the applicable building code.

2.3 The in-service moisture content of the I-joists shall be 16 percent or less.

2.4 Repetitive member factor for use with allowable bending moment calculations shall be 1.0.

2.5 The I-Joists and WEBshield Panels recognized in this report are produced by Pinkwood, Ltd., in Calgary, Alberta.

3.0 PRODUCT USE INSTRUCTIONS

3.1 Design: Design of Pinkwood I-Joists described in this report is governed by the applicable building code and the corresponding edition of ANSI/AWC National Design Specification for Wood Construction (NDS). The allowable design properties for Pinkwood I-Joists are listed in [Table 2](#) and [Table 3](#) of this report. For wood diaphragm applications, design shall be in accordance with the applicable code, using allowable shear capacities specified in [Table 9](#) of this report for wind or seismic design of horizontal wood structural panel diaphragms framed with Pinkwood I-Joists.

3.2 Installation: Installation of Pinkwood I-Joists shall conform to the Pinkwood I-Joist installation details, this evaluation report, and the applicable provisions of the building code. Where there is a conflict between these documents, the most restrictive provisions shall govern. The manufacturer's installation instructions and this report shall be available at the jobsite during construction for use by installers and for quality assurance.

3.2.1 Lateral Support: The compression flanges of I-joists shall have continuous lateral support, and the joists shall be restrained at supports to prevent rollover. Methods specified in the applicable code for lateral support of sawn lumber are acceptable. Bridging is not required for floor and roof joist applications, unless specified by the design.

3.2.2 Bearing Stiffeners: Field-installed bearing stiffeners shall be provided at end bearings when end reactions exceed those permitted by [Table 3](#) of this report for unstiffened webs. Bearing stiffeners shall be installed at interior supports when intermediate reactions exceed those permitted by [Table 3](#) of this report for unstiffened webs. The stiffeners shall be installed as shown in [Figure 2](#) and shall be the dimensions shown in [Table 5](#) of this report.

3.2.3 Web Stiffeners: Field-installed web stiffeners are required at points of concentrated loads and shall be installed in accordance with [Figure 2](#) of this report.

3.3 Fasteners: The design of fasteners driven into the flanges of Pinkwood I-Joists shall comply with the applicable code and this section. [Table 6](#) of this report specifies the equivalent specific gravity of the flanges for fastener design. [Table 7](#) of this report specifies the requirements of the spacing of nails driven into the flange face of the I-joist.

3.4 Blocking Panels: Bearing walls perpendicular to and supported by I-joists require full depth blocking or rim joists at supports. When used as blocking panels, the maximum vertical load transfer capacities of Pinkwood I-Joists are specified in [Table 8](#) of this report.



3.5 Resistance to Fire and Flame-Spread

3.5.1 Fire-Resistance-Rated Floor-Ceiling Assemblies:

Pinkwood I-joists are recognized for use in fire-resistance-rated floor-ceiling assemblies constructed in accordance with the prescriptive details in Item Numbers 21-1.1, 23-1.1, 24-1.1, 25-1.1, 26-1.1, 27-1.1, and 28-1.1 of IBC Table 721.1(3).

3.5.2 Fire Protection of Floors: Pinkwood FRI Assembly offers equivalent fire performance to 2-inch by 10-inch nominal dimension lumber and is recognized for installation without the prescribed minimum 1/2-inch-thick (12.7 mm) gypsum wallboard or 5/8-inch-thick (15.9 mm) wood structural panel membrane in accordance with Exception 4 to 2012 IRC Section R501.3 or 2015 and 2018 IRC Section R302.13, when installed as described in this report. Pinkwood FRI Assembly consists of Pinkwood I-joists as described in Section 3.5.2.1 and Pinkwood WEBshield panels as described in Section 3.5.2.2, of this report. Pinkwood FRI Assembly is used for applications having maximum live load of 40 psf and maximum dead load of 20 psf.

3.5.2.1 Pinkwood I-Joists Used in Pinkwood FRI Assembly: When used in FRI Assembly, Pinkwood I-Joists are limited to 9 1/2-inch (241 mm) through 14-inch (356 mm) depths. The allowable moment capacities for the Pinkwood I-Joists ([Table 2](#) of this report) shall be adjusted in accordance with this section and [Table 10](#) of this report, based on WEBshield coverage. The moment capacities shall be multiplied by a factor of 0.82 for minimum WEBshield coverage in accordance with [Figure 1](#) and [Table 11](#) of this report. Panels added to exceed minimum WEBshield coverage may be installed symmetrically about the I-joist center line in accordance with [Table 10](#) of this report to increase the length of web protection and reclaim part or all of the allowable moment capacities.

3.5.2.2 WEBshield Panels: WEBshield Panels are proprietary OSB panels, typically 15/32-inch-thick (11.91 mm), 24 inches (610 mm) long, and manufactured to just fit between the top and bottom flanges to protect the webs of Pinkwood I-Joists in FRI Assembly. Alternatively, for I-joists 11 7/8-inch and deeper, proprietary 3/8-inch-thick (9.53 mm) coated WEBshield Panels may be used in lieu of uncoated 15/32-inch-thick (11.91 mm) WEBshield Panels. The 3/8-inch-thick (9.53 mm) WEBshield Panels are coated with *PS5005-PinkShield*, a coating formulated to improve fire resistance and flame-spread performance at a thickness defined in the Quality Assurance Manual – Supplement for Fire-Rated Products. The panels shall be installed in accordance with the prescriptive details in [Figure 1](#) of this report corresponding to the WEBshield panel type.

3.5.3 Flame-Spread Resistance: Pinkwood I-Joists are available with their entire webs coated using *PS5005-PinkShield* for enhanced surface-burning performance. The coating is applied to the I-joist webs at a defined thickness

and minimum coverage in accordance with the Pinkwood Quality Assurance Manual – Supplement for Fire-Rated Products. Pinkwood I-Joists with coated webs are identified by the letters FRB added to the Pinkwood I-Joist series designation. Webs coated with *PS5005-PinkShield* exhibit an ASTM E84 Flame-spread Index of 75 or less.

3.6 Holes in the Web: Round, square, rectangular, and grouped smaller holes are permitted in the I-joists in accordance with the limitations set forth in [Figure 3](#) of this report. [Table 12](#) of this report outlines the circular hole locations for uniformly loaded, simple or multiple span Pinkwood I-Joists when live loads do not exceed 40 psf (1.9 kN/m²) and dead loads do not exceed 15 psf (0.72 kN/m²).

Alternatively, allowable sizes and locations of web holes may be determined by analysis comparing the required shear capacity of the I-joist at the hole location to the reduced shear capacity of the I-joist due to the size of a circular hole at that location. The reduced I-joist shear capacity shall be calculated using the following formula:

$$\text{Published Shear Value} \times \left[\frac{\text{Joist Depth} - \text{Hole Diameter}}{\text{Joist Depth}} \right]$$

3.6.1 Web holes in FRI Assembly: Holes in the webs of Pinkwood I-Joists used in FRI assembly are subject to the maximum size and location requirements of Section 3.6 of this report for structural design. Additionally, where the desired hole coincides with the location of a WEBshield panel, the following rules apply:

- a. A hole not exceeding 1 1/2 inches (38.1 mm) in diameter may be located anywhere within the WEBshield panel.
- b. The back-to-back panels may be moved as described in [Figure 1](#) of this report.
- c. When moving the panels is not practical and a 1 1/2-inch-diameter (38.1 mm) hole is insufficient for the specific end-use application, a single maximum 6-inch-diameter (152 mm) hole may be cut in the WEBshield panels. When such hole is required, additional 6-inch-wide (152 mm) full-depth WEBshield panels shall be installed back-to-back adjacent to the penetrated panels and fastened to the web as described in [Figure 1](#) of this report, using a minimum of one fastener top and bottom of each panel in accordance with Pinkwood's installation instructions.

4.0 PRODUCT DESCRIPTION

Pinkwood I-Joists are prefabricated wood I-joists conforming to the requirements of IBC Section 2303.1.2 and 2012 IRC Section R502.1.4 or 2015 and 2018 IRC Section R502.1.2. The flanges are made of proprietary finger-jointed sawn lumber with a minimum specific gravity of 0.42. The



webs are made of nominally $3/8$ - or $7/16$ -inch-thick (9.53 mm or 11.1 mm) Exposure 1 OSB, depending on the I-joist series. The adhesive used to make the web-to-web, web-to-flange, and flange-to-flange connections complies with ASTM D2559, and ASTM D7247 for heat durability. Pinkwood I-Joists are manufactured in six series: PKI10, PKI20, PKI23, PKI35 Plus, PKI40, and PKI50, and various depths as described in [Table 1](#) of this report. The I-joists are available in lengths up to 58 feet (17.7 m).

**TABLE 1
PINKWOOD I-JOIST SERIES AND SIZES**

Series	I-Joist Depths, inches	Flange Size (w x h), inches	Nominal Flange Width ¹ , inches	Webstock
PKI10	9 $\frac{1}{2}$ to 14	2 $\frac{1}{2}$ x1 $\frac{1}{2}$	3	$3/8$ " OSB
PKI20	9 $\frac{1}{2}$ to 16	2 $\frac{1}{2}$ x1 $\frac{1}{2}$	3	$3/8$ " OSB
PKI23	9 $\frac{1}{2}$ to 16	2 $\frac{1}{2}$ x1 $\frac{1}{2}$	3	$7/16$ " OSB
PKI35 plus	9 $\frac{1}{2}$ to 16	3 $\frac{1}{2}$ x1 $\frac{1}{2}$	4	$3/8$ " OSB
PKI40	9 $\frac{1}{2}$ to 16	3 $\frac{1}{2}$ x1 $\frac{1}{2}$	4	$3/8$ " OSB
	18 to 24		4	$7/16$ " OSB
PKI50	11 $\frac{7}{8}$ to 24	3 $\frac{1}{2}$ x1 $\frac{1}{2}$	4	$7/16$ " OSB

For S.1.: 1 inch = 25.4 mm

1. Applies to the Nominal Width of Framing Members column in Table 9.

The WEBshield panels are as described in Section 3.5.2.2 of this report.

5.0 IDENTIFICATION

Pinkwood I-Joists are identified with the manufacturer's name (Pinkwood Ltd.), the product name (PKI), the series name, I-joist depth, and the evaluation report number (ER-431).

Bundles of I-joist are identified with the series, depth, and length of the I-joists.

The UES Mark of Conformity is included to demonstrate recognition. Either Mark of Conformity may be used as shown:

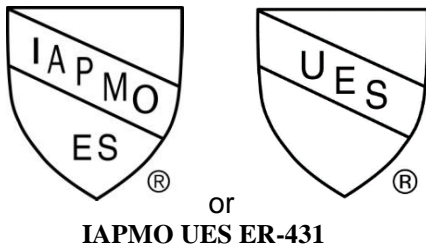

6.0 SUBSTANTIATING DATA

6.1 Data and analysis in accordance with ICC-ES

Acceptance Criteria for Prefabricated Wood I-Joists (AC14), approved October 2017 and ASTM D5055, Standard Specification for Establishing and Monitoring Structural Capacities of Prefabricated Wood I-Joists.

6.2 Reports of full-scale diaphragm testing in accordance with AC14, Section A2.3.2.

6.3 Documentation describing the manufacturer's quality management system in accordance with AC14 Appendix B.

6.4 Pinkwood I-Joist Floor Installation Details and product descriptive literature.

6.5 Reports of fire-resistance testing demonstrating equivalent fire performance to 2-inch by 10-inch nominal dimension lumber in accordance with AC14, Section A4.4 – Fire Protection of Floors.

6.6 Report of flame-spread testing in accordance with CAN/ULC S-102.

7.0 STATEMENT OF RECOGNITION

This report describes the results of research carried out by the IAPMO Uniform Evaluation Service on Pinkwood I-Joists to assess their conformance to the codes and standards listed in Section 1.0 and serves as documentation of the product certification. The products are manufactured at locations noted in Section 2.5 of this report under a quality control program with periodic inspection under the supervision of IAPMO UES.

Brian Gerber, P.E., S.E.
Vice President, Technical Operations
Uniform Evaluation Service

Richard Beck, PE, CBO, MCP
Vice President, Uniform Evaluation Service

GP Russ Chaney
CEO, The IAPMO Group

For additional information about this evaluation report please visit www.uniform-es.org or email us at info@uniform-es.org



TABLE 2 – DESIGN PROPERTIES FOR PINKWOOD I-JOISTS (ALLOWABLE STRESS DESIGN) (1)

Joist Series	Joist Type	Joist Depth (inches)	Bending Stiffness EI (x10 ⁶ lbf-in ²)	Allowable Moment, M ⁽²⁾ (lbf-ft)	Shear (lbf)	Shear Deflection Coefficient K ⁽³⁾ (x10 ⁶ lbf)
PKI10	PKI10-10	9 ½	168	2,365	1,260	4.94
	PKI10-12	11 7/8	286	3,100	1,485	6.18
	PKI10-14	14	420	3,720	1,680	7.28
PKI20	PKI20-10	9 ½	193	2,810	1,260	4.94
	PKI20-12	11 7/8	327	3,755	1,485	6.18
	PKI20-14	14	479	4,405	1,680	7.28
	PKI20-16	16	652	5,060	1,870	8.32
PKI23	PKI23-10	9 ½	208	3,330	1,585	4.94
	PKI23-12	11 7/8	352	4,320	1,805	6.18
	PKI23-14	14	515	5,200	2,005	7.28
	PKI23-16	16	700	6,030	2,190	8.32
PKI35 Plus	PKI35Plus-10	9 ½	234	3,395	1,260	4.94
	PKI35Plus-12	11 7/8	396	4,395	1,485	6.18
	PKI35Plus-14	14	580	5,270	1,680	7.28
	PKI35Plus-16	16	787	5,990	1,870	8.32
PKI40	PKI40-10	9 ½	328	5,390	1,340	4.94
	PKI40-12	11 7/8	553	6,970 ⁽²⁾	1,625	6.18
	PKI40-14	14	807	8,395	1,875	7.28
	PKI40-16	16	1092	9,730	2,115	8.32
	PKI40-18	18	1421	11,005	2,535	9.36
	PKI40-20	20	1799	12,175	2,680	10.40
	PKI40-22	22	2224	13,335	2,815	11.44
	PKI40-24	24	2698	14,480	2,945	12.48
PKI50	PKI50-12	11 7/8	565	7,955	2,135	6.18
	PKI50-14	14	824	9,200	2,280	7.28
	PKI50-16	16	1115	10,655	2,415	8.32
	PKI50-18	18	1453	12,770	2,535	9.36
	PKI50-20	20	1839	14,175	2,680	10.40
	PKI50-22	22	2273	14,590	2,815	11.44
	PKI50-24	24	2757	15,845	2,945	12.48

For S.I.: 1 inch = 25.4 mm; 1 lbf = 4.4 N

Notes to Table 2:

- The tabulated values are ASD design values for normal duration of load (C_D = 1.0). All values, except for EI, K, and VLC shall be permitted to be adjusted for other load durations as permitted by the ANSI/AWC National Design Specification (NDS) Section 2.3.2.
- When a Pinkwood I-Joist is used in Pinkwood FRI Assembly as per Section 3.5.2.1 of this report, its allowable moment, M, shall be multiplied by a moment reduction factor of 0.82.
- For calculating the maximum (center of span) uniform load and center point load deflections of an I-joist in a simple-span application, Equations 1 and 2 shall be used.

$$\text{Uniform Load: } \delta = \frac{5\omega\ell^4}{384EI} + \frac{\omega\ell^2}{K} \quad [1]$$

$$\text{Center-Point Load: } \delta = \frac{P\ell^3}{48EI} + \frac{2P\ell}{K} \quad [2]$$

Where:

- δ = calculated deflection (in.)
- ω = uniform load (lbf/in.)
- P = concentrated load (lbf)
- ℓ = design span (in.)
- EI = bending stiffness of the I-joist (lbf-in.²)
- K = coefficient of shear deflection (lbf)



TABLE 3 - REACTION CAPACITIES FOR PINKWOOD I-JOISTS - (ALLOWABLE STRESS DESIGN)⁽¹⁾⁽²⁾⁽³⁾

Joist Series	Joist Type	Joist Depth (inches)	End Reaction (lbf)				Intermediate Reaction (lbf)				Flange Bearing Capacities (lbf/in)
			1 1/2" or 2 1/2" Bearing ⁽⁴⁾		3 1/2" or 4" Bearing ⁽⁵⁾		3 1/2" Bearing		5 1/2" Bearing		
			Web Stiff.		Web Stiff.		Web Stiff.		Web Stiff.		
			No	Yes	No	Yes	No	Yes	No	Yes	
PKI10	PKI10-10	9 1/2	900	1,140	1,110	1,260	2,195	2,280	2,450	2,520	955
	PKI10-12	11 7/8	900	1,275	1,160	1,485	2,195	2,485	2,525	2,810	955
	PKI10-14	14	900	1,395	1,200	1,680	2,195	2,665	2,585	2,960	955
PKI20	PKI20-10	9 1/2	970	1,140	1,110	1,260	2,195	2,375	2,450	2,635	955
	PKI20-12	11 7/8	970	1,275	1,160	1,485	2,330	2,525	2,595	2,830	955
	PKI20-14	14	970	1,395	1,200	1,680	2,455	2,665	2,725	3,005	955
	PKI20-16	16	970	1,510	1,240	1,870	2,570	2,795	2,850	3,175	955
PKI23	PKI23-10	9 1/2	1,050	1,430	1,350	1,500	2,410	2,770	2,850	3,210	1,180
	PKI23-12	11 7/8	1,050	1,470	1,435	1,680	2,410	2,770	2,850	3,280	1,180
	PKI23-14	14	1,050	1,505	1,485	1,845	2,410	2,770	2,850	3,340	1,180
	PKI23-16	16	1,050	1,540	1,500	2,000	2,410	2,770	2,850	3,400	1,180
PKI35 Plus	PKI35Plus-10	9 1/2	900	1,140	1,110	1,260	2,195	2,280	2,450	2,520	1,380
	PKI35Plus-12	11 7/8	900	1,275	1,160	1,485	2,195	2,485	2,525	2,810	1,380
	PKI35Plus-14	14	900	1,395	1,200	1,680	2,195	2,665	2,585	2,960	1,380
	PKI35Plus-16	16	900	1,510	1,240	1,865	2,195	2,880	2,645	3,105	1,380
PKI40	PKI40-10	9 1/2	1,185	1,340	1,305	1,340	2,900	3,095	2,940	3,195	1,705
	PKI40-12	11 7/8	1,245	1,510	1,595	1,625	3,025	3,340	3,120	3,515	1,705
	PKI40-14	14	1,280	1,660	1,595	1,875	3,085	3,565	3,280	3,805	1,705
	PKI40-16	16	1,295	1,800	1,595	2,115	3,145	3,775	3,435	4,080	1,705
	PKI40-18	18	1,310	2,060	1,680	2,550	2,850	4,285	3,435	4,970	1,705
	PKI40-20	20	1,310	2,185	1,680	2,640	2,850	4,410	3,435	4,970	1,705
	PKI40-22	22	1,310	2,310	1,680	2,735	2,850	4,530	3,435	4,970	1,705
	PKI40-24	24	1,310	2,440	1,680	2,830	2,850	4,640	3,435	4,970	1,705
PKI50	PKI50-12	11 7/8	1,245	1,510	1,595	1,625	3,025	3,340	3,120	3,515	1,995
	PKI50-14	14	1,280	1,660	1,595	1,875	3,085	3,565	3,280	3,805	1,995
	PKI50-16	16	1,295	1,800	1,595	2,115	3,145	3,775	3,435	4,080	1,995
	PKI50-18	18	1,310	2,060	1,680	2,550	2,850	4,285	3,435	4,970	1,995
	PKI50-20	20	1,310	2,185	1,680	2,640	2,850	4,410	3,435	4,970	1,995
	PKI50-22	22	1,310	2,310	1,680	2,735	2,850	4,530	3,435	4,970	1,995
	PKI50-24	24	1,310	2,440	1,680	2,830	2,850	4,640	3,435	4,970	1,995

For S.I.: 1 inch = 25.4 mm; 1 lbf = 4.4 N

Notes to Table 3:

1. Reaction capacity shall be limited by the flange bearing capacity or the bearing capacity of the support material, whichever is less. The flange bearing capacity, per inch of bearing length, is based on the allowable compression perpendicular-to-grain of the I-joist flange, accounting for eased edges.
2. Reaction capacity is for normal duration of load and shall be permitted to be adjusted for other load durations provided that the adjusted reaction capacity is not greater than the flange bearing capacity or the bearing capacity of the support material, which shall not be increased for any load durations.
3. Reaction capacity shall be permitted to be increased over that tabulated for the minimum bearing length by linear interpolation of the reaction capacity between the minimum and maximum bearing lengths. Extrapolation beyond the minimum and maximum bearing lengths is beyond the scope of this table.
4. For the I-joist with the depth equal to or less than 16 inches, the minimum bearing length of end reaction is 1½ inches; For the I-joist with the depth equal to or larger than 18 inches, the minimum bearing length of end reaction is 2½ inches.
5. For PKI23 series, the maximum end bearing length is 3¾ inches. For all other series, the maximum end bearing length is 4 inches.

- 1) Wood I-jolst per plan
- 2) WEBshield panels
- 3) Fastener zones - one fastener to be installed in each of the 6 zones
- 4) 2 additional fasteners required for 15/32" WEBshield.

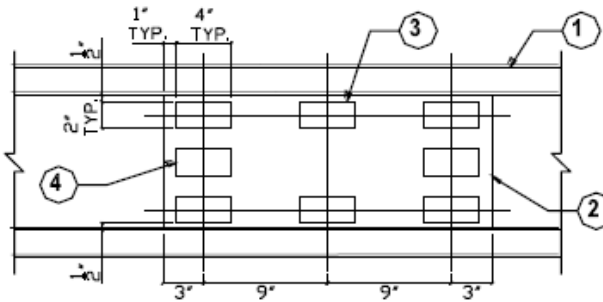

See Table 4 for alternate/additional fastening requirements

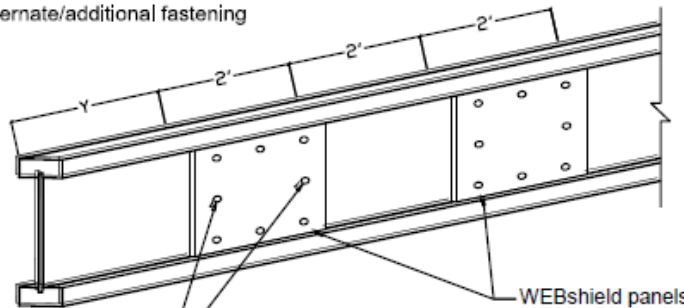

Additional fasteners at mid-I-jolst depth required for 15/32" WEBshield only

See Table 11 - Minimum Quantity of WEBshield Panels

- WEBshield panels shall be installed tightly against the I-jolst web at prescribed intervals, back-to-back on each side, to protect the web against exposure to flame. Fasten each panel using 16-gauge by 7/16-inch-crown staples, or equivalent, according to the following specifications for the given WEBshield type:
- **Installation Details:** Use (6) 3/4-inch-long staples, minimum, to attach 3/8-inch-thick coated WEBshield panels as shown. Use (8) 3/4-inch-long staples, minimum, to attach 15/32-inch-thick uncoated WEBshield panels as shown. WEBshield panels shall be installed at 4-foot-on-center spacing intervals with a 0.5" spacing tolerance. End panels shall begin within 2 feet from the ends of the I-jolsts (dimension y).
- The 3/4-inch-long fasteners shall be installed at 90 degrees to the panel surface for adequate penetration to hold the panel against the I-jolst web.

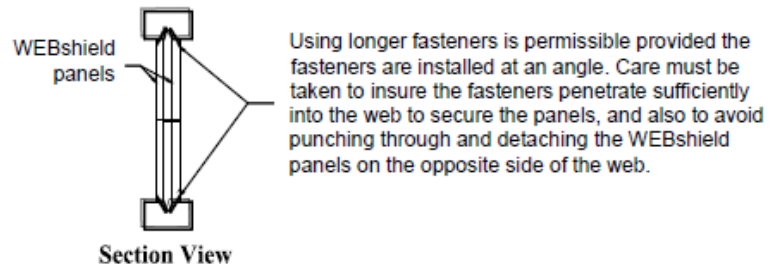
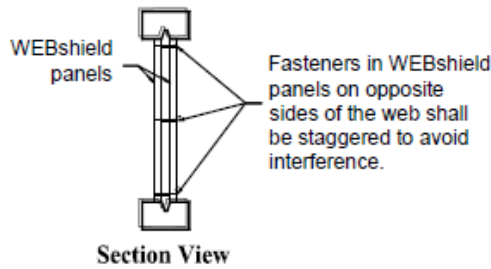

TABLE 4 - PRESCRIBED FASTENING FOR WEBSHIELD PANEL INSTALLATION USING STAPLES

Fastening Options	Fastening at 90 degrees to WEBshield Panel Surface				Fastening at Angle to WEBshield Panel Surface			
	Edge Staples		Mid-depth Staples		Edge Staples		Mid-depth Staples	
	Staple Count	Staple Length	Staple Count	Staple Length	Staple Count	Staple Length	Staple Count	Staple Length
15/32" WEBshield	6	3/4"	2	3/4"	6	1-1/4"	2	3/4" ⁽¹⁾
3/8" Coated WEBshield	6	3/4"	optional	optional	6	1-1/4"	optional	optional

For SI: 1 inch = 25.4 mm

1) 3/4-inch mid-depth staple shall be driven at 90 degrees to the panel surface.

FIGURE 1 - WEBshield Installation Details

TABLE 5 - WEB AND BEARING STIFFENER SIZE REQUIREMENTS

PKI Flange Width	Required Size of Stiffener (each side of web)
2 1/2 inches	1-inch thick stiffener by minimum 2 ⁵ / ₁₆ inches wide
3 1/2 inches	1 1/2-inch thick stiffener by minimum 2 ⁵ / ₁₆ inches wide

For S.I.: 1 inch = 25.4 mm

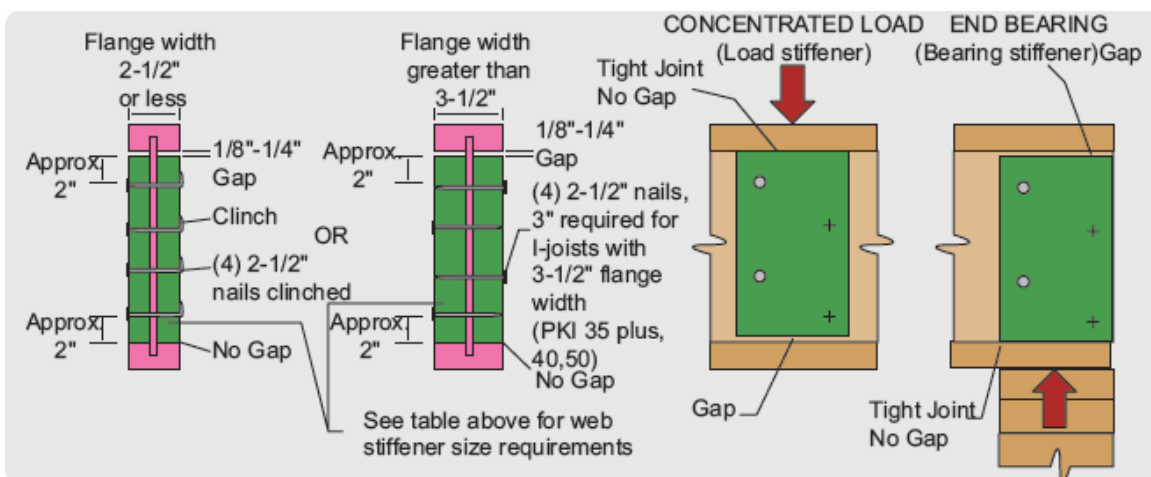

FIGURE 2 – WEB AND BEARING STIFFENER DETAILS

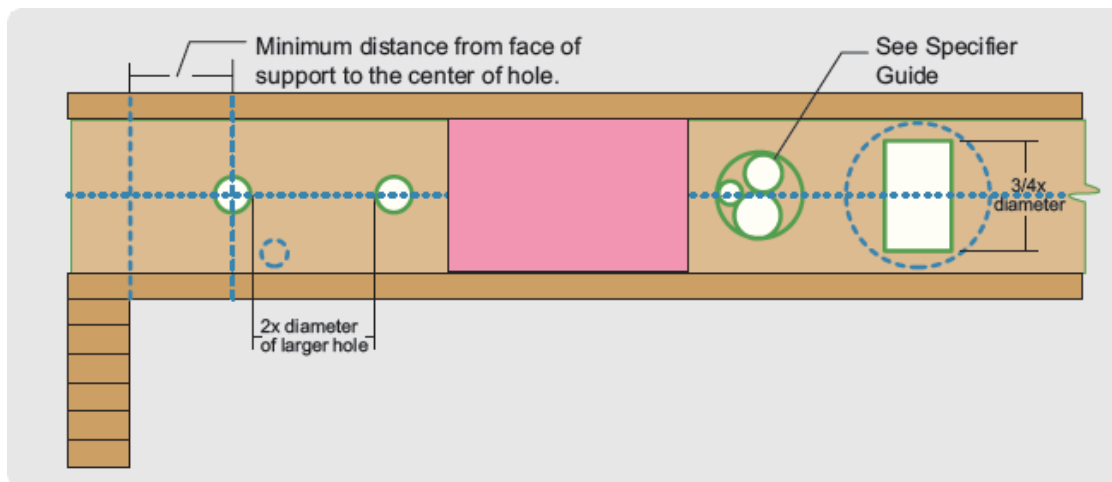

FIGURE 3 – ALLOWABLE HOLES IN WEBS

Rules for cutting holes in PKI Joists

1. The distance between the inside edge of the support and the center line of any hole shall comply with the requirements of Table 12 of this report.
2. I-joint top and bottom flanges shall NEVER be cut, notched or otherwise modified.
3. Whenever possible, field-cut holes should be centered on the middle of the web.
4. The maximum size hole that may be cut into an I-joint web shall equal the clear distance between the flanges of the I-joint minus 1/4 inch. A minimum of 1/8 inch shall always be maintained between the top or bottom of the hole and the adjacent I-joint flange.
5. The sides of square holes or longest sides of rectangular holes shall not exceed three-fourths of the diameter of the maximum round hole permitted at that location.
6. Where more than one hole is necessary, the distance between adjacent hole edges shall exceed twice the diameter of the largest round hole or twice the size of the largest square hole (or twice the length of the longest side of the longest rectangular hole) and each hole shall be sized and located in compliance with the requirements of Table 12 of this report.
7. Holes measuring 1 1/2 inches diameter or smaller shall be permitted anywhere in a cantilevered section of a PKI Joist. Holes of greater size may be permitted subject to verification.
8. A 1 1/2-inch-diameter or smaller hole may be placed anywhere in the web provided the position complies with the requirements of rule No.6 above.
9. All holes shall be cut in a workman-like manner in accordance with the restrictions listed above and as illustrated in Figure 3 of this report.
10. Up to three maximum-size holes are permitted per span.
11. A group of round holes at approximately the same location shall be permitted if they meet the requirements for a single round hole circumscribed around them.



TABLE 6 - MINIMUM EQUIVALENT SPECIFIC GRAVITY FOR DESIGN OF NAIL CONNECTIONS

Joist Series	Minimum Equivalent Specific Gravity for Design of Nail Connections ^{1,2}
PKI10	0.42
PKI20	0.42
PKI23	0.46
PKI35Plus ³	0.42
PKI40	0.46
PKI50	0.50

Note to Table 6:

1. Equivalent specific gravity of Pinkwood I-joists is for uses in accordance with ANSI/AWC NDS.
2. Specific Gravity listed above are minimum values. Increased values may be available upon request.
3. For PKI35Plus series, the specific gravity of 0.50 is available for its flange material if required.

TABLE 7 - FLANGE FACE NAILING^{1, 2}

Joist Series	Nail Type	Nail Size		Minimum Distance from Joist End (in)	Closest O/C Nail Spacing (in)
		Length (in)	Diameter (in)		
PKI10	8d box	2 1/2	0.113	1	2
	8d common	2 1/2	0.131	1	2
	8d sinker	2 3/8	0.113	1	2
	10d sinker	2 7/8	0.120	1	2
PKI20	10d box	3	0.128	1	2
PKI23	12d box	3 1/4	0.128	1	2
PKI35Plus	10d common	3	0.148	1.5	3
PKI40	12d common	3 1/4	0.148	1.5	3
PKI50	12d sinker	3 1/8	0.135	1.5	3
	16d sinker	3 1/4	0.148	1.5	3
	16d box	3 1/2	0.135	1.5	4
	16d common	3 1/2	0.162	1.5	4

For SI: 1 inch = 25.4 mm

Notes to Table 7:

1. If more than one row of nails is required, the rows must be offset a minimum of 1/2" and staggered.
2. Nails into the edges of Pinkwood I-Joist flanges may be spaced in accordance with the applicable provisions in NDS.

TABLE 8 - I-JOIST BLOCKING PANEL CAPACITIES¹

Joist Depth (inches)	Uniform Vertical Load Capacity (lbf/ft)					
	PKI10	PKI20	PKI23	PKI35 Plus	PKI40	PKI50
9 1/2	2,000	2,000	2,000	2,000	2,000	-
11 7/8	2,000	2,000	2,000	2,000	2,000	2,000
14	2,000	2,000	2,000	2,000	2,000	2,000
16	-	2,000	2,000	2,000	2,000	2,000
18	-	-	-	-	1,800	1,800
20	-	-	-	-	1,600	1,600
22	-	-	-	-	1,300	1,300
24	-	-	-	-	1,100	1,100

For SI: 1 inch = 25.4 mm; 1 lbf/ft = 14.5939 N/m.

Note to Table 8:

1. Above table provides the uniform vertical load capacity of Pinkwood I-Joists when used for blocking panels. For the allowable shear capacities of horizontal wood structural panel diaphragms framed with Pinkwood I-Joists for wind and seismic design, please see Table 9 of this report.



TABLE 9 - ALLOWABLE SHEAR (POUND PER FOOT) FOR HORIZONTAL WOOD STRUCTURAL PANEL DIAPHRAGMS FRAMED WITH PINKWOOD I-JOISTS FOR WIND¹ OR SEISMIC LOADING^{2,3}

Panel Grade	Common Nail Size	Minimum Nominal Panel Thickness ⁴ (inch)	Minimum Nominal Width of Framing Members at Adjoining Panel Edges and Boundaries ^{5,6} (inches)	Blocked Diaphragms			Unblocked Diaphragms	
				Nail spacing (inches) at diaphragm boundaries (all cases) at continuous panel edges parallel to load (Cases 3, 4), and at all panel edges (Cases 5, 6) ^{7,8}			Nails spaced 6" max. at supported edges ⁷	
				6	4	2.5		
				Nail spacing (inches) at other panel edges (Cases 1, 2, 3 and 4) ⁷			Case 1 (No unblocked edges or continuous joints parallel to load)	All other configurations (Cases 2, 3, 4, 5 and 6)
6	6	4						
Structural I Grades	6d ⁹	5/16	3	210	280	420	185	140
	8d	3/8	3	300	400	600	265	200
	10d	15/32	3	360	480	720	320	240
Sheathing, single floor and other grades covered in DOC PS 1 and PS 2	6d ⁹	5/16	3	190	250	380	170	125
		3/8	3	210	280	420	185	140
	8d	3/8	3	270	360	540	240	180
		7/16	3	285	380	570	255	190
		15/32	3	300	400	600	265	200
	10d	15/32	3	325	430	650	290	215
		19/32	3	360	480	720	320	240

For SI: 1 inch = 25.4, 1 pound per foot = 14.5939 N/m.

Notes to Table 9:

1. Data excerpted from SDPWS Tables 4.2A & 4.2C for ASD design. For wind design, the allowable shear capacities in the table above shall be increased 40 percent.
2. For shear loads of normal or permanent load duration as defined by the ANSI/AWC NDS, the values in the table above shall be multiplied by 0.63 or 0.56, respectively.
3. The tabulated allowable shear capacities are for I-joint series with flanges having a specific gravity (G) of 0.50 or higher. For G<0.50, the allowable shear capacities shall be reduced by multiplying the allowable shear capacities by the Specific Gravity Adjustment Factor = [1-(0.5-G)], where the specific gravity could be found from Table 6. The Specific Gravity Adjustment Factor shall not be greater than 1.
4. The panel shall not be less than 4' x 8' except at boundaries and changes in framing where minimum panel dimension shall be 24" unless all edges of the undersized panel are supported by and fastened to framing members or blockings.
5. See Table 1 for nominal width of framing member for Pinkwood I-Joists.
6. The minimum nominal width of framing members not located at boundaries or adjoining panel edges shall be 2 inches.
7. Space nails maximum 12 inches o.c. along intermediate framing members (6 inches o.c. where supports are spaced 48 inches o.c. or greater). Nails shall be located at least 3/8" from the edge of panels.
8. When nail spacing is less than 6 inches on centre at diaphragm boundaries, adjacent nails within a row must be offset (staggered) 1/2 inch.
9. 8d is recommend minimum for roofs due to negative pressures of high winds.



TABLE 10 - PERCENTAGE INCREASE IN MOMENT CAPACITY FOR ADDITIONAL WEBSHIELD PANELS

Span (ft)	Additional WEBshield Panel Installed Symmetrically About Joist Center Line ¹ (in)	Percent Increase in Moment Capacity ² (%)	Span (ft)	Additional WEBshield Panel Installed Symmetrically About Joist Center Line ¹ (in)	Percent Increase in Moment Capacity ² (%)	Span (ft)	Additional WEBshield Panel Installed Symmetrically About Joist Center Line ¹ (in)	Percent Increase in Moment Capacity ² (%)		
8	0	7.1	15	0	3.8	20	0	2.1		
	6	11.6		6	6.0		6	3.7		
	12	16.1		12	8.3		12	5.4		
	18	18.0		18	10.5		18	7.0		
	24	18.0		24	12.8		24	8.6		
9	0	1.5		30	15.0		30	10.3		
	6	5.1		36	17.3		36	11.9		
	12	8.7		42	18.0		42	13.5		
	18	12.3		48	18.0		48	15.2		
	24	15.9		0	7.1		54	16.8		
	30	18.0	6	9.3	60	18.0				
10	0	7.1	16	12	11.6	21	66	18.0		
	6	10.7		18	13.8		0	4.7		
	12	14.3		24	16.1		6	6.4		
	18	17.9		30	18.0		12	8.0		
	24	18.0		36	18.0		18	9.6		
	30	18.0		42	18.0		24	11.3		
11	0	11.6		17	48		18.0	22	30	12.9
	6	15.2			0		4.2		36	14.5
	12	18.0			6		6.2		42	16.2
	18	18.0			12		8.2		48	17.8
	24	18.0	18		10.2	54	18.0			
	30	18.0	24		12.2	60	18.0			
12	0	7.1	18		30	14.2	22		66	18.0
	6	10.1			36	16.2			0	2.6
	12	13.1			42	18.0			6	4.1
	18	16.1			48	18.0			12	5.6
	24	18.0		54	18.0	18		7.1		
	30	18.0		0	1.5	24		8.6		
13	0	3.3		19	6	3.3		22	30	10.1
	6	5.8			12	5.1			36	11.6
	12	8.4			18	6.9			42	13.1
	18	11.0			24	8.7			48	14.5
	24	13.5	30		10.5	54	16.0			
	30	16.1	36		12.3	60	17.5			
	36	18.0	42		14.1	66	18.0			
	42	18.0	48		15.9	72	18.0			
14	0	0.0	19		54	17.7	22		0	0.0
	6	2.2			60	18.0			0	0.0
	12	4.5		0	0.0	6		1.6		
	18	6.7		6	3.3	12		3.3		
	24	9.0		18	4.9	18		4.9		
	30	11.2		24	6.5	24		6.5		
	36	13.5		30	8.2	30		8.2		
	42	15.7		36	9.8	36		9.8		
	48	18.0		42	11.4	42		11.4		
		48		13.1	48	13.1				
		54	14.7	54	14.7					
		60	16.4	60	16.4					
		66	18.0	66	18.0					

Notes to Table 10:

1. Additional WEBshield panel refers to the WEBshield panel in addition to the typical WEBshield panel as specified in Figure 1 of this report. The total length of the additional WEBshield panel added to joist web shall be double the lengths indicated in the above Table.
2. Percent increase refers to the percent increase of I-joist moment capacity of Pinkwood FRI Assembly.



TABLE 11 - MINIMUM QUANTITY OF WEBSHIELD PANELS

15/32" WEBshield Panel								
Joist Span ≤	WEBshield Length 24" 12"		Joist Span ≤	WEBshield Length 24" 12"		Joist Span ≤	WEBshield Length 24" 12"	
	Min. Quantity			Min. Quantity			Min. Quantity	
26'	12		18'	8		10'		6
25'	10	2	17'	8		9'		6
24'	10		16'	8		8'		6
23'	10		15'	6	2	7'		4
22'	10		14'	6		6'		4
21'	10		13'	6		5'		4
20'	8	2	12'	6		4'		4
19'	8		11'	6		3'		2
3/8" WEBshield Panel with PS5005-PinkShield Coating ^{1,2}								
Joist Span ≤	WEBshield Length 24" 12"		Joist Span ≤	WEBshield Length 24" 12"		Joist Span ≤	WEBshield Length 24" 12"	
	Min. Quantity			Min. Quantity			Min. Quantity	
26'	12		18'	8		10'	4	
25'	12		17'	8		9'	4	
24'	12		16'	8		8'	4	
23'	10	2	15'	6	2	7'	2	2
22'	10		14'	6		6'	2	
21'	10		13'	6		5'	2	
20'	10		12'	6		4'	2	
19'	8	2	11'	4	2	3'		2

Note:

1. The minimum quantity of 3/8" WEBshield panels in above table is based on typical spacings between WEBshield panels, it doesn't account for any reductions due to increased spacing between WEBshield panels as specified in Figure 1 of this report.
2. Use of 3/8-inch WEBshield panels in Pinkwood FRI assemblies for Fire Protection of floors as specified in Section 3.5.2.2 of this report is not applicable to 9 1/2 -inch I-joists.



EVALUATION REPORT

Number: 431

Originally Issued: 03/25/2016

Revised: 03/29/2019

Valid Through: 03/31/2020

Table 12 - LOCATION OF CIRCULAR HOLES IN PKI JOIST WEBS

Simple or Multiple Span for Live Loads up to 40 psf and Dead Loads up to 15 psf

Joist Depth	Series	SAF	Minimum Distance from Inside Face of Any Supports to Center of Hole (ft-in)																										
			Round Hole Diameter (in.)																										
			2	3	4	5	6	6 1/4	7	8	8 5/8	9	10	10 3/4	11	12	12 3/4	13	14	14 3/4	15	16	16 3/4	17	18	18 3/4	19	20	20 3/4
9 1/2"	PKI10-10	12.91	1'-1"	1'-2"	1'-8"	2'-11"	4'-4"	4'-9"																					
	PKI20-10	14.09	1'-1"	1'-2"	2'-5"	3'-9"	5'-2"	5'-7"																					
	PKI23-10	14.83	1'-1"	1'-2"	1'-5"	3'-1"	4'-10"	5'-3"																					
	PKI35Plus-10	15.32	1'-1"	1'-2"	2'-1"	3'-5"	4'-9"	6'-3"	6'-9"																				
	PKI40-10	16.81	2'-0"	3'-4"	4'-9"	6'-4"	7'-11"	8'-4"																					
11 7/8"	PKI10-12	14.81	1'-1"	1'-2"	1'-2"	1'-8"	2'-10"	3'-2"	4'-2"	5'-6"	6'-7"																		
	PKI20-12	16.32	1'-1"	1'-2"	1'-5"	2'-8"	3'-11"	4'-3"	5'-2"	6'-8"	7'-11"																		
	PKI23-12	17.52	1'-1"	1'-2"	1'-2"	1'-8"	3'-1"	3'-6"	4'-8"	6'-4"	7'-6"																		
	PKI35Plus-12	17.67	1'-1"	1'-2"	2'-4"	3'-7"	4'-10"	5'-2"	6'-2"	7'-9"	9'-1"																		
	PKI40-12	19.96	1'-5"	2'-9"	4'-1"	5'-6"	6'-11"	7'-3"	8'-5"	10'-1"	11'-2"																		
14"	PKI10-14	20.08	1'-1"	1'-2"	1'-2"	2'-7"	4'-5"	4'-10"	6'-3"	8'-2"	9'-6"																		
	PKI20-14	16.24	1'-1"	1'-2"	1'-2"	1'-3"	1'-8"	1'-11"	2'-9"	4'-0"	4'-9"	5'-3"	6'-8"	8'-2"															
	PKI23-14	17.69	1'-1"	1'-2"	1'-2"	1'-5"	2'-7"	2'-10"	3'-9"	5'-0"	5'-10"	6'-4"	7'-10"	9'-8"															
	PKI23-14	19.24	1'-1"	1'-2"	1'-2"	1'-3"	1'-10"	2'-2"	3'-2"	4'-7"	5'-7"	6'-2"	7'-9"	9'-6"															
	PKI35Plus-14	18.42	1'-1"	1'-2"	1'-3"	2'-5"	3'-7"	3'-10"	4'-9"	6'-1"	6'-11"	7'-6"	9'-4"	11'-5"															
16"	PKI40-14	22.63	1'-1"	2'-2"	3'-5"	4'-9"	6'-1"	6'-5"	7'-6"	8'-11"	9'-11"	10'-6"	12'-2"	13'-7"															
	PKI50-14	22.76	1'-1"	1'-2"	1'-2"	2'-4"	3'-11"	4'-4"	5'-6"	7'-3"	8'-4"	9'-0"	10'-11"	12'-5"															
	PKI20-16	18.97	1'-1"	1'-2"	1'-2"	1'-3"	1'-5"	1'-8"	2'-6"	3'-8"	4'-5"	4'-10"	6'-1"	7'-1"	7'-5"	9'-3"	11'-3"												
	PKI23-16	19.94	1'-1"	1'-2"	1'-2"	1'-3"	1'-3"	1'-4"	1'-5"	2'-9"	3'-7"	4'-1"	5'-8"	7'-0"	7'-5"	9'-5"	11'-7"												
	PKI35Plus-16	18.71	1'-1"	1'-2"	1'-2"	1'-5"	2'-6"	2'-10"	3'-8"	4'-10"	5'-7"	6'-1"	7'-4"	8'-4"	8'-9"	11'-0"	13'-0"												
18"	PKI40-16	25.03	1'-1"	1'-2"	2'-3"	3'-7"	4'-10"	5'-2"	6'-2"	7'-6"	8'-5"	9'-0"	10'-6"	11'-9"	12'-2"	14'-3"	15'-10"												
	PKI50-16	25.17	1'-1"	1'-2"	1'-2"	2'-2"	3'-7"	3'-11"	5'-1"	6'-7"	7'-7"	8'-2"	9'-10"	11'-1"	11'-7"	13'-5"	15'-0"												
	PKI40-18	27.24	1'-1"	1'-2"	1'-2"	1'-3"	2'-5"	2'-9"	3'-9"	5'-1"	6'-0"	6'-6"	8'-0"	9'-2"	9'-6"	11'-2"	12'-8"	13'-2"	15'-6"	17'-6"									
	PKI50-18	27.41	1'-1"	1'-2"	1'-2"	2'-3"	3'-7"	3'-11"	4'-11"	6'-4"	7'-3"	7'-9"	9'-3"	10'-5"	10'-10"	12'-5"	13'-9"	14'-2"	16'-0"	17'-8"									
	PKI40-20	29.48	1'-1"	1'-2"	1'-2"	1'-3"	1'-7"	1'-11"	2'-10"	4'-2"	4'-11"	5'-5"	6'-10"	7'-10"	8'-2"	9'-7"	10'-9"	11'-1"	12'-11"	14'-8"	15'-3"	17'-9"	20'-1"						
20"	PKI50-20	29.66	1'-1"	1'-2"	1'-2"	1'-10"	3'-1"	3'-5"	4'-4"	5'-8"	6'-6"	7'-0"	8'-5"	9'-6"	9'-10"	11'-3"	12'-5"	12'-10"	14'-5"	15'-9"	16'-3"	18'-5"	20'-3"						
	PKI40-22	30.34	1'-1"	1'-2"	1'-2"	1'-3"	1'-3"	1'-4"	2'-1"	3'-3"	4'-1"	4'-6"	5'-9"	6'-9"	7'-1"	8'-5"	9'-5"	9'-9"	11'-2"	12'-4"	12'-9"	14'-10"	16'-7"	17'-4"	20'-5"	22'-10"			
	PKI50-22	30.34	1'-1"	1'-2"	1'-2"	1'-3"	1'-10"	2'-1"	3'-0"	4'-3"	5'-0"	5'-6"	6'-9"	7'-9"	8'-1"	9'-5"	10'-5"	10'-9"	12'-2"	13'-6"	13'-11"	16'-1"	17'-10"	18'-5"	20'-10"	23'-1"			
	PKI40-24	30.34	1'-1"	1'-2"	1'-2"	1'-3"	1'-3"	1'-4"	1'-4"	2'-6"	3'-3"	3'-8"	4'-10"	5'-9"	6'-1"	7'-4"	8'-3"	8'-7"	9'-10"	10'-10"	11'-2"	12'-7"	13'-11"	14'-5"	16'-10"	18'-11"	19'-8"	22'-9"	25'-2"
	PKI50-24	30.34	1'-1"	1'-2"	1'-2"	1'-3"	1'-3"	1'-4"	2'-2"	3'-4"	4'-1"	4'-6"	5'-9"	6'-8"	6'-11"	8'-2"	9'-2"	9'-6"	10'-9"	11'-10"	12'-2"	13'-10"	15'-3"	15'-9"	17'-11"	19'-7"	20'-4"	23'-4"	25'-10"

For S.I.: 1 inch = 25.4 mm

Notes:

- (a) This table may be used for I-joist spacing of 24 inches on center, or less.
- (b) Hole location distance is measured from inside face of supports to center of hole.
- (c) Distances in this chart are based on uniformly loaded joists.
- (d) Hole sizes and/or locations that fall outside the scope of this table may be acceptable based on analysis of actual hole size, span, spacing and loading conditions. The I-joist shear capacity at the location of a circular web hole (V_n) is calculated using the following equation:

$$\text{Published Shear Value } x \left(\frac{\text{Joist Depth} - \text{Hole Diameter}}{\text{Joist Depth}} \right)$$
- (e) SAF = Span Adjustment Factor, used as defined below:

Optional: Table 12 is based on the I-joists used at their maximum span. If the I-joists are placed at less than their full allowable span, the maximum distance from the centerline of the hole to the face of any support (D) as indicated, may be reduced as follows:

$$D_{\text{reduced}} = (L_{\text{actual}} / \text{SAF}) \times D$$

Where: D_{reduced} = Distance from the inside face of any support to center of hole, reduced for less-than-maximum span applications (ft). The reduced distance shall not be less than 12 inches from the face of the support to edge of the hole.

L_{actual} = The actual measured span distance between the inside faces of supports (ft).

SAF = Span Adjustment Factor given in this table.

D = The minimum distance from the inside face of any support to center of hole from this table.

If $L_{\text{actual}} / \text{SAF}$ is greater than 1, use 1 in the above calculation for $L_{\text{actual}} / \text{SAF}$